



*2021 Product Guide*



**WALDEN**  
PREMIER

# WALDEN PREMIER MATERIALS REFERENCE

PATTERN CODE	PATTERN NAME	PRICE GROUP	EDGE BINDING	SLIDING PANEL	COORDINATED WAND COLOR	MAXIMUM SIZE FOR MOTORIZED SHADES (SQUARE FEET)	
						WITHOUT LINER	WITH LINER
E-M01	Aires White	F	Y	Y	White	64	64
E-87K	Alder Oak	B	Y	Y	Beige	44	38
E-432	Artisan Weave	E	Y	N	Bronze	44	38
E-416	Aspen Cedar	C	Y	Y	Bronze	44	38
E-416-3	Aspen Ebony	C	Y	Y	Black	44	38
E-082	Aspen Walnut	C	Y	Y	Bronze	44	38
E-416-4	Aspen White	C	Y	Y	White	44	38
E-R26	Bamboo Forest	B	Y	Y	Bronze	44	38
E-365	Barcelona Café	B	Y	Y	Bronze	54	44
E-861	Bora Bora	B	Y	Y	Beige	50	42
E-430	Capri Natural	D	Y	Y	Beige	64	56
E-389	Catalina	E	Y	Y	Beige	64	64
E-E11	Devon Ivory	A	Y	Y	Beige	56	45
E-E06	Devon Maple	A	Y	Y	Beige	56	45
E-E02	Devon White	A	Y	Y	White	56	45
E-68N	Driftwood Natural	B	Y	Y	Beige	44	38
E-055	Java Cocoa	B	Y	Y	Bronze	54	44
E-B01	Mandalay Umber	C	Y	Y	Black	33	30
E-801	Mykonos Dunes	F	Y	Y	Beige	64	56
E-390	Natural Jute	E	Y	Y	Beige	64	56
E-803	Navarre White Sand	F	Y	Y	White	64	56
E-P01	Orleans Macaroon	E	Y	N	White	64	64
E-403-B	Penang Oak	A	Y	Y	Bronze	56	45
E-427	Prairie Golden	E	Y	Y	Beige	64	56
E-828	Prairie Snow	F	Y	Y	Beige	64	56
E-428	Prairie White	E	Y	Y	Beige	64	56
E-M04	Remi Breeze	E	Y	Y	Gray	64	56
E-001	Sakura Oregano	C	Y	Y	Bronze	54	44
E-352	Savanna Husk	C	Y	Y	Bronze	64	56
E-U01	Saybrook Stone	E	Y	Y	Gray	56	45
E-U03	Seaside White	F	Y	Y	Beige	56	45
E-370	Sierra Sand	D	Y	N	Bronze	50	42
E-438	Sunshade Brown	A	Y	Y	Bronze	54	48
E-10H	Sunshade White	C	Y	Y	White	44	38
E-394	Tamarind Sunset	B	Y	Y	Bronze	44	38
E-805	Telluride Frost	D	Y	Y	White	44	38
E-806	Telluride Thunder	D	Y	Y	Beige	44	38

## EDGE BINDINGS

COLOR	COLOR NUMBER	WIDTH
NARROW EDGE BINDING		
Beige	N3	1"
Black	N10	1"
Chocolate	N4	1"
Copper	N5	1"
Cream	N8	1"
Desert Sand	N6	1"
Light Beige	N2	1"
Natural	N15	1"
Sienna	N11	1"
White	N1	1"
WIDE EDGE BINDING		
Beige	W3	3"
Black	W10	3"
Chocolate	W4	3"
Copper	W5	3"
Cream	W8	3"
Desert Sand	W6	3"
Light Beige	W2	3"
Natural	W15	3"
Sienna	W11	3"
White	W1	3"

Edge Binding on the face of the shade will be 1/2 the width above.

## LINERS

COLOR NUMBER	COLOR
PRIVACY LINERS	
NK-L	Privacy Beige
NC-L	Privacy Chocolate
W4-L	Privacy White
BLACK-OUT LINERS	
K3-D	Black-Out Beige
C2-D	Black-Out Chocolate
W4-D	Black-Out White

Privacy Liners are the same color on both sides.

Black-Out Liners are off-white to the street.

All fabrics have a maximum width of 96".

# SHADE STYLES

All standard shade styles operate with a cord lock and are supplied with cord cleats to keep the cords tidy and away from children or pets.

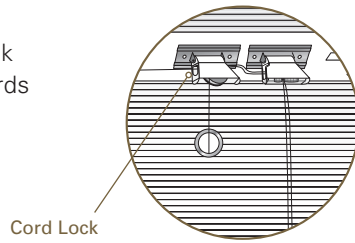

Cord Lock

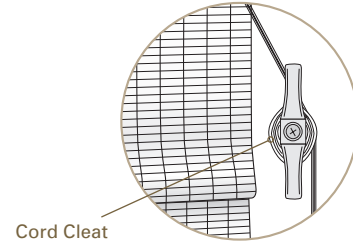

Cord Cleat

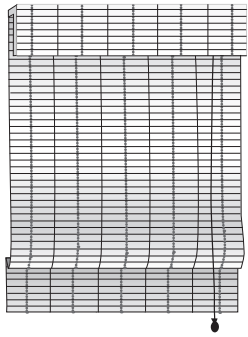

## STANDARD ROMAN SHADE

Shade material is attached to the back of the head rail. Shade includes a 6" valance to conceal the components. When raised, the material rises from the bottom in flat folds.

Shades operated by cords (cord lock or cord loop) will have controls in front of the shade.

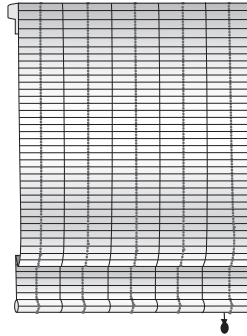

## WATERFALL SHADE

Shade material is attached to the front of the head rail, without a valance. When raised, the material rises from the bottom in flat folds. Optional back valance is available upon request.

Shades operated by cords (cord lock or cord loop) will have controls behind the shade.

## VALANCE RETURNS

Outside mount shades are recommended to be ordered with valance returns. Returns for both outside and inside mount shades are available free of charge if requested at the time the order is placed.

Standard valance returns are made using the shade material. Valance returns can also be made using edge binding material upon request; this is a surcharge option.

Standard valance return height will be 1 1/2" less than the valance height. This length will keep the rolled bottom of the valance from interfering with the return.

Optional short valance returns are also available. Short returns cover the end of the head rail and hide the components, keeping the stack of the raised shade away from the returns.

Custom valance return lengths are available to be ordered upon request.

All valance returns will be made with an L-shaped connector to attach to the back of the valance. This holds the returns in place and creates a clean, finished corner.

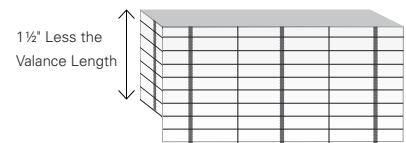

Standard Valance Return

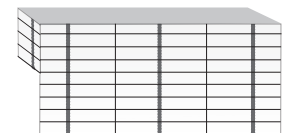

Short Valance Return

# SHADE OPTIONS

## LINERS

A liner can be ordered attached to the back of the shade or as a separate operable, movable liner (see Twin Shade below).

## ATTACHED LINERS

Attached liners are available in privacy or black-out. They are secured to the back of the shade by stitches at each side of the liner. If a shade is lined, the valance will automatically be lined with the same material.

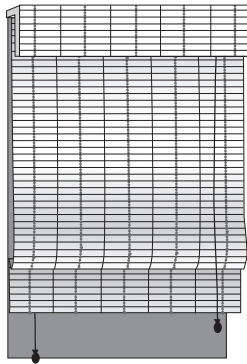

shown with controls on opposite sides

## TWIN SHADE

Features two separate, independently operated shades on one head rail. The front shade can be either a standard or waterfall woven wood shade.

A separate liner shade is attached to the back of the head rail and both shades operate independently. Lift cords can be on the same side (factory standard) or opposite sides of the shade.

Outside mount twin shades will be made with a valance that is  $\frac{3}{4}$ " wider than the ordered shade width. This will allow the returns to fit behind the valance.

See Specifications for head rail sizes.

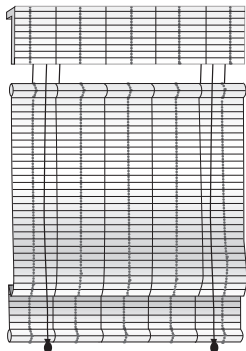

controls always on opposite sides

## TOP-DOWN BOTTOM-UP SHADES

Top-Down Bottom-Up (TDBU) shades can be raised from the bottom or lowered from the top. This is accomplished with two separate sets of control cords positioned at opposite sides of the shade. Available with attached liners and edge binding.

To conceal the cord locks and pulleys each shade will be finished with a 6" lined valance. This is included in the TDBU surcharge.

Outside mount TDBU shades will be made with a valance that is  $\frac{3}{4}$ " wider than the ordered shade width. This will allow the returns to fit behind the valance.

The maximum width for TDBU shades is 84". TDBU shades are only available with cord lock controls and are not available in waterfall style, with movable liners, or as multiple shades on one head rail. The default control sides for TDBU shades are top down on the left, bottom up on the right.

## MULTIPLE SHADES ON ONE HEAD RAIL

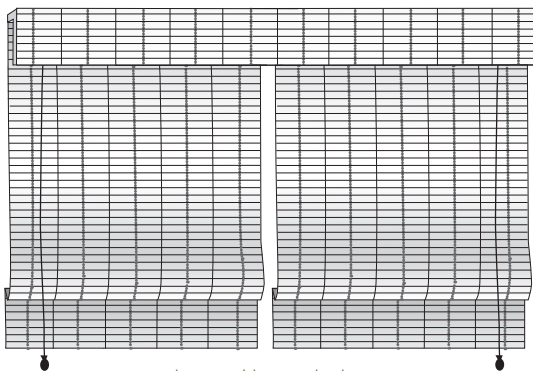

shown with two shades

Shades are available with 2-on-1 or 3-on-1 head rail. The maximum total width is 115" and the gap between shades will be no more than  $\frac{1}{2}$ ". The maximum width for a common valance is 96"; wider valances will be made in sections to match the individual shade widths.

Multiple shades on one head rail are available to be ordered with all control types except top-down bottom-up. Pay careful attention to make sure there are suitable locations for cord tensioners or cord cleats when specifying multiple shades on one head rail, particularly for the middle shade in 3-on-1 head rail units.

# SHADE CONTROL OPTIONS

## CLUTCH CONTROLS

Clutches provide an assisted lift for large or heavy shades, and come standard with color-coordinated cord loops available in one foot increments from 2' to 6'. The factory will choose the length closest to  $\frac{2}{3}$  rds shade height, unless otherwise requested. Nickel-plated bead chain loops are available as a surcharge option and can be made to custom lengths. Clutches are available with all shade styles except TDBU.

All cord/chain loops must be secured to the wall to prevent the loop from becoming a strangulation hazard to small children or pets. All clutch shades will be shipped with tensioners for the cord/chain loops. It is important when measuring for clutch shades that a suitable location for the tensioner be identified and the length of the loop drop measured to this location. **Always install tensioners.**

Standard shades ordered with a clutch come "clutch adjacent" to keep the stack of the raised shade from interfering with the loop. This means the shade fabric will be  $\frac{5}{8}$ " narrower for inside mount and  $\frac{7}{8}$ " narrower for outside mount than the ordered width on the control side, allowing the cord to hang to the side of the shade. This may cause a light gap on black-out shades.

Waterfall shades ordered with clutch controls will have control loops behind the shade and are not available to be ordered as clutch adjacent.

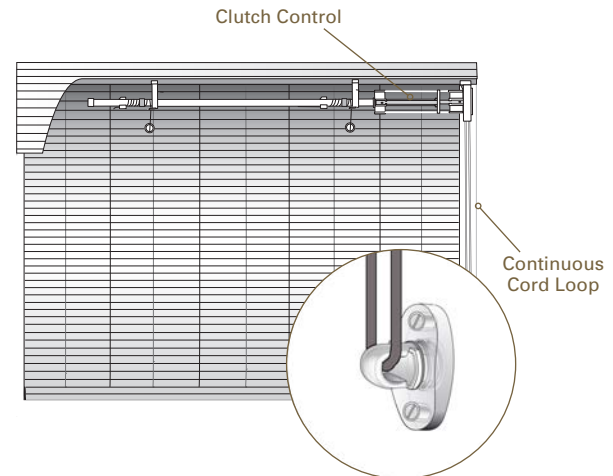

Cord/Chain Tensioner

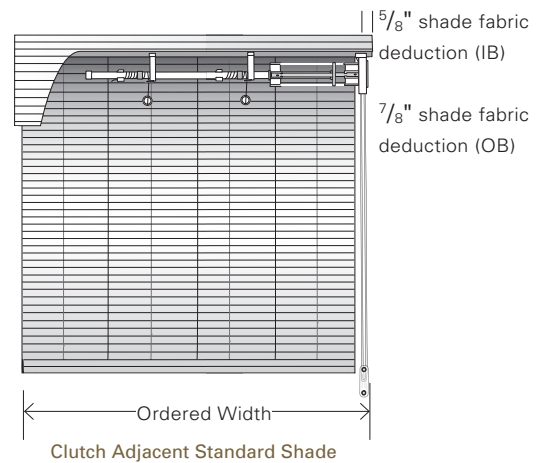

Clutch Adjacent Standard Shade

## CORDLESS SHADES

Cordless shades operate with no lift cords on the front of the shade. The shade is lowered by pulling on the hem bar. A spring control system, located under the wooden head rail, holds the shade in place at any desired position.

Clear grips are added to the hem bar of cordless shades; one per shade up to 72" wide and two for wider shades.

The cordless option is not available on TDBU shades.

Cordless shades are available up to 96" wide and 96" long and will be mounted on standard depth head rails (see Specifications for details).

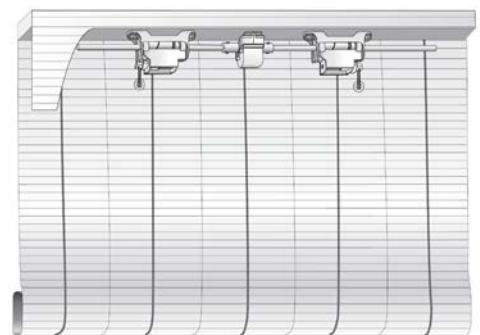

Cordless Shade

# SHADE CONTROL OPTIONS

## REMOTE CONTROL SHADES

Minimum widths by motor type are listed on the Specifications chart (page 9). Check the Materials Reference table for the maximum size of shade which can be operated by this battery motor.

### LITHIUM ION BATTERY MOTOR:

- Motor powered by re-chargeable lithium ion battery.
- Shade battery recharged via a port in the motor head.

### QUIET LIFT LITHIUM ION BATTERY MOTOR:

- Upgraded re-chargeable lithium ion battery motor that features a more quiet lift.
- Shade battery recharged via a port in the motor head.

### DC MOTOR:

- 12V DC motor. Transformer is not included.
  - Powered through an external battery pack\* (included), or low voltage wiring with a power distribution panel\*\*.
- \*Battery pack is powered by a battery tube that requires 8 1.5V alkaline AA batteries. Batteries are not included with battery pack.*
- \*\*Power distribution panel is not available through this collection.*

### AC MOTOR:

- 100V - 240V AC motor with built-in transformer and 2' pigtail.
- Requires installation by an electrician.

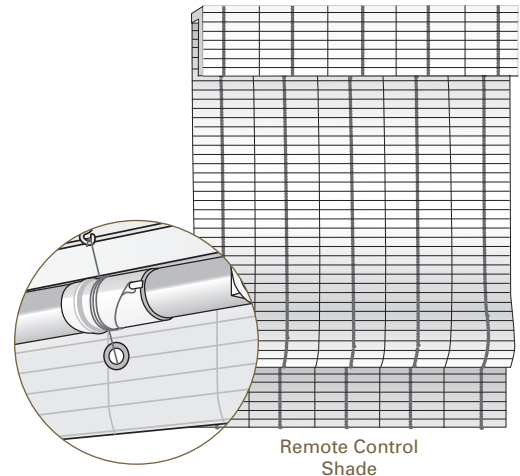

Motor tube and spindle

Remote Control Shade

## REMOTE CONTROL OPERATION

- **Single- and multi-channel (15) remotes**  
Each channel on multi-channel remote can operate 20 shades.
- **Single- and multi-channel (15) wireless wall switches**
- **Connector Hub**  
Provides automated control capabilities through smart phones as well as Google Home, Amazon Alexa, and Siri.



REMOTE  
(multi-channel)



WALL SWITCH  
(multi-channel)



CONNECTOR HUB

# SHADE CONTROL OPTIONS

## WAND CONTROL SHADES

Wand control motorized shades are powered by the same internal lithium-ion battery as remote control shades. The motor is controlled using a wand which hangs down to the side of the shade.

Waterfall shades cannot be ordered with wand controls.

Wands are available in 4 lengths: 24", 36", 48", and 60".

Available colors include: white, beige, gray, bronze, and black.

Wand control shade motor batteries are recharged via a mini USB power adaptor which plugs into the end of the wand.

Check the Materials Reference table for the maximum size of shade which can be operated by this battery motor.

All wand control shades will be made with shade fabric  $\frac{5}{8}$ " narrower for inside mount and  $\frac{7}{8}$ " narrower for outside mount than the ordered width on the control side, allowing the wand to hang to the side of the shade. This may cause a light gap on black-out shades.

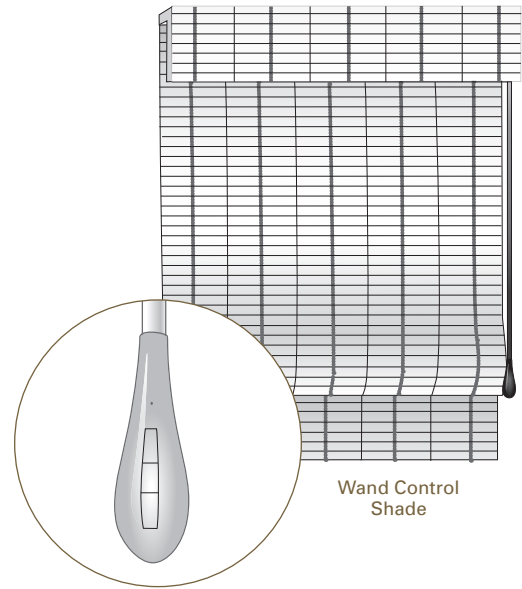

White, beige, gray, bronze, or black wands

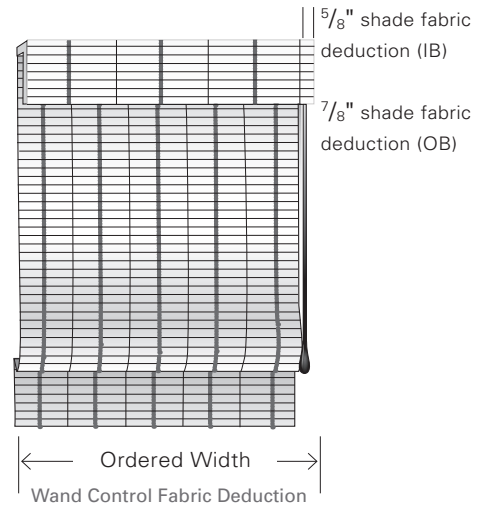

# SHADE ADDITIONAL OPTIONS

## ADDITIONAL OPTIONS

### LINED VALANCE

Lined valances are recommended to conceal the head rail components where an open-weave pattern is selected. All TDBU shades are made with lined valances as standard.

### EDGE BINDINGS

Available in two widths: 1" (1/2" on the face of the shade) and 3" (1 1/2" on the face of the shade).

Edge binding is applied to the sides of both the shade and valance. It is not applied to the bottom of either.

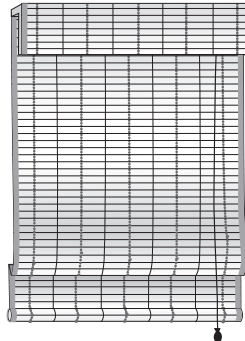

Standard Shade  
shown with narrow edge binding

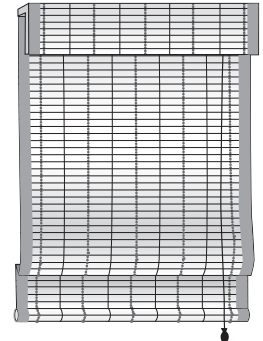

Standard Shade  
shown with wide edge binding

### CUT OUTS

Cut outs can be taken from either side of the shade. Exact dimensions and the locations of the cut outs are required.

Cut outs are not available with edge binding.

There may be limitations to what can be cut out, based upon the size and specifications of the shade. The factory will review all orders for cut outs and provide confirmation of each order within 24 hours.

### HOLD DOWN BRACKETS AND SPACER BLOCKS

Hold down brackets are supplied upon request for all control types. Cord lock, clutch, and motorized shades ordered with hold down brackets will be made with a round bottom bar. Cordless shades with hold down brackets will be made with a rectangular bottom bar.

Spacer blocks measuring 3/8" are available upon request. Maximum of 2 spacer blocks per bracket recommended.

# SHADE SPECIFICATIONS

	MINIMUM WIDTH	MAXIMUM WIDTH	MINIMUM HEIGHT	HEIGHT	IB DEDUCTION (WIDTH)	FLUSH IB DEPTH (top mount w/brkt)	MINIMUM IB DEPTH (top mount w/brkt)
STANDARD HEAD RAIL (CORDED)	12"	96"	18"	108"	3/8"	2 1/2"*	3/4"
NARROW HEAD RAIL (CORDED)	12"	96"	18"	108"	3/8"	2"*	3/4"
STANDARD TWIN	12"	96"	18"	108"	3/8"	3 3/4"*	3/4"
CLUTCH and LOOP	18"	96"	18"	108"	3/8"	3 3/4"*	3/4"
CORDLESS	18"	96"	18"	96"	3/8"	2 1/2"*	3/4"
TOP-DOWN BOTTOM-UP (TDBU)	12"	84"	18"	108"	3/8"	2 1/2"*	3/4"
WAND CONTROL	23"	96"	18"	108"	3/8"	3 3/4"*	3/4"
Remote Control Motors							
• LITHIUM ION	23"	96"	18"	108"	3/8"	3 3/4"*	3/4"
• QUIET LIFT	29 1/2"	96"	18"	108"	3/8"	3 3/4"*	3/4"
• DC MOTOR	15"	96"	18"	108"	3/8"	3 3/4"*	3/4"
• AC MOTOR	20"	96"	18"	108"	3/8"	3 3/4"*	3/4"
MULTIPLE SHADES ON ONE HR	-	115" total	-	-	-	-	-
COMMON VALANCE	-	96"	-	-	-	-	-

\* Flush IB depth is head rail depth plus 1" when using standard bracket. Exact measurement will vary slightly based upon fabric thickness.

## BRACKET DIMENSIONS

Height: 1 1/2"  
Depth: 1 3/4"

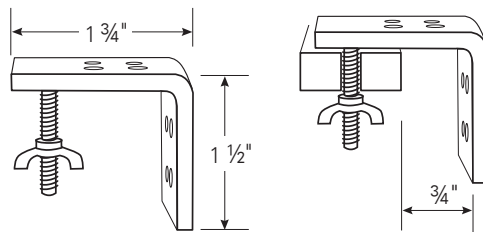

## RING SPACING

First fold starts at 3 1/2" above the bottom bar, then rings are spaced 7" apart on back of the shade.

## STACK HEIGHT

Ring spacing: 7"  
Stack height (all lengths): 8" to 10"

## HEAD RAIL DIMENSIONS

Middle support brackets will be supplied for all shades over 41" wide.

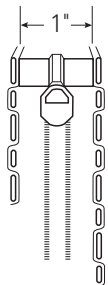

**NARROW HEAD RAIL**  
(Custom Order Only)  
• Standard Shades  
• Waterfall Shades

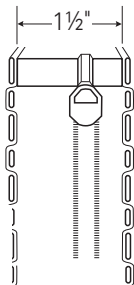

**STANDARD HEAD RAIL**  
• Standard Shades  
• Waterfall Shades  
• TDBU Shades

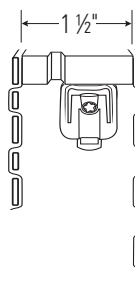

**CORDLESS HEAD RAIL**  
• Standard Shades  
• Waterfall Shades

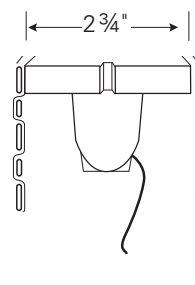

**MOTORIZED HEAD RAIL**  
**REMOTE OR WAND CONTROL**  
• Standard Shades  
• Waterfall Shades

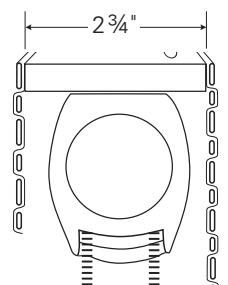

**CLUTCH SHADE**  
with Continuous Cord Loop (shown)

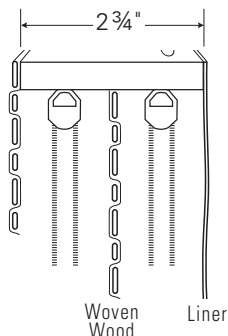

**STANDARD TWIN SHADE**  
Controls Same Side (shown)  
or Opposite Sides

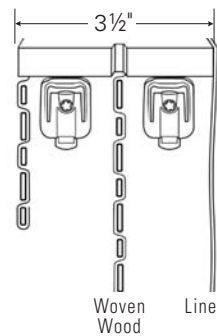

**TWIN SHADE w/CORDLESS**

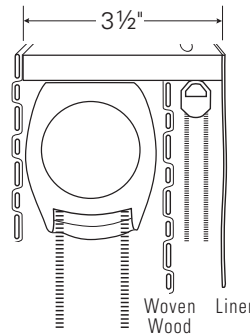

**TWIN SHADE w/CLUTCH**  
(Clutch Control for Front Shade Only)  
Controls Same Side (shown)  
or Opposite Sides

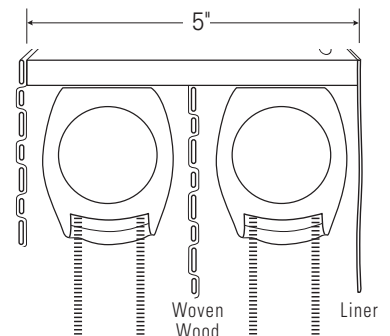

**TWIN SHADE w/2 CLUTCHES**  
Controls Same Side (shown)  
or Opposite Sides

# SLIDING PANELS

## CONSTRUCTION AND OPERATION

- Sliding panels provide a clean, contemporary look for large windows and doors.
- Overlapping panels are suspended from hangers, which glide smoothly on an aluminum track and pass in front or behind each other, allowing panels to stack away from the window.
- Panels are attached to the track and are supplied with narrow edge binding to protect them from wear and tear and are custom-sized, based on the ordered width and the number of panels.
- Sliding panels are operated with 48" wood wands; a center opening sliding panel will have two wands.
- Check the Materials Reference table for patterns which are available to be made as Sliding Panels.



Wand Colors

**NOTE:** Because bamboo and natural materials can stretch or shrink, we recommend that panels are ordered with at least  $\frac{3}{4}$ " clearance from the ground. When shipped from the factory, panels may be slightly different lengths (up to  $\frac{1}{2}$ " from the ordered length). A shorter panel can be corrected by gently pulling on the bottom of the panel until it is the same length as longer panels.

## ONE-WAY OPENING

- When open, all of panels stack back to either the right or the left. *Specify on the order to which side of the window the panels will stack.*
- The standard configuration is for the rear panel to be stationary and all the other panels stack in front.
- Reverse stacking is available, with the front panel stationary. Free-floating panels are also available.
- **NOTE:** If you want the panels to stack completely away from the window for an unobstructed view, allow for the panel width in the overall width of the shade. See "Specifications" for more details.

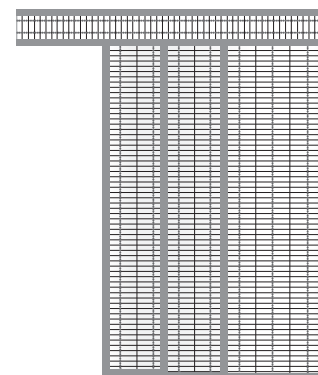

One-Way Right Stacked

## CENTER OPENING (SPLIT DRAW)

- Must be made with an even number of panels. Panels stack to both sides.
- When made with four panels, the back left and front right panels are stationary.
- If made with six or eight panels, the rear panels on both sides will be stationary and all other panels will stack in front on both sides. See Sliding Panel Configurations on page 13.
- Reverse stacking and free-floating panels are also available.

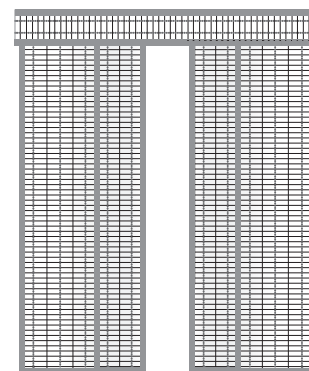

Center Opening

# SLIDING PANELS

## LINERS

- Available in light-filtering or black-out.
- Sewn under the edge binding on all four panel sides.

## EDGE BINDING

- Panels will come with narrow (1") edge binding as standard, which means that ½" is visible on the face of the panels.
- Wide (3") edge binding is also available in the same colors as a surcharge option.

## VALANCE

- Valances are 8" long and attached to the front and sides of the track by velcro. If a valance is part of the original sliding panel order, the velcro for the valance will be riveted to the front of the track to ensure a lasting bond.
- Valances are cut up the roll, so they wrap around the ends of the track. This means the valance material is railroaded and will be oriented differently to the panels. For inside mount sliding panels, the valance will cover the front of the track only. For outside mount sliding panels the valance will be made to wrap around both ends of the track.
- When ordered separately, both velcro halves are provided, but the bond between the velcro and the track will not be as durable.

# SLIDING PANEL SPECIFICATIONS

## SIZE LIMITATIONS

Minimum Width: 48" Minimum Height: 24"  
 Maximum Width: 144" Maximum Height: 96"

Tracks wider than 90" are spliced to avoid oversize freight charges.

## STANDARD PANEL CONFIGURATIONS

WIDTH	TYPE OF OPENING	# OF PANELS	TRACK TYPE
48" – 84"	One-Way	3 Panels	3 Channel
	Center Opening	4 Panels	4 Channel
84 1/4" – 120"	One-Way	4 Panels	4 Channel
	Center Opening	4 Panels	4 Channel
120 1/4" – 144"	One-Way	5 Panels	5 Channel
	Center Opening	6 Panels	3 Channel

## TYPICAL PANEL SIZES (OUTSIDE MOUNT SHADE)

WIDTH	ONE-WAY DRAW		CENTER OPENING	
60"	3 panels	21 5/8"	4 panels	16 7/8"
72"	3 panels	25 5/8"	4 panels	19 7/8"
84"	3 panels	29 5/8"	4 panels	22 7/8"
96"	4 panels	25 7/8"	4 panels	25 7/8"
108"	4 panels	28 7/8"	4 panels	28 7/8"
120"	4 panels	31 7/8"	4 panels	31 7/8"
132"	5 panels	28 3/8"	6 panels	24 1/8"
144"	5 panels	30 3/4"	6 panels	26 1/4"

## PANEL SIZE CALCULATIONS

To calculate the approximate panel width, use the ordered width and the number of panels.

Deduct one from the number of panels and multiply this number by 2.5. Then add this number to the ordered width and divide the resulting number by the number of panels.

**For example:** For a sliding panel order with an 80" width and 5 panels, each panel will be approximately 18" wide.

$$5 \text{ (panels)} - 1 = 4$$

$$4 \times 2.5 = 10"$$

$$80" \text{ (ordered width)} + 10" = 90"$$

$$90" / 5 \text{ (panels)} = 18" \text{ panel width}$$

## TRACK DIMENSIONS

TRACK DEPTHS	
3 Channel	2"
4 Channel	2 3/4"
5 Channel	3 3/8"

The distance from the top of the track to the top of the panels is 1". The factory will take account of this distance when calculating the panel length.

## MOUNTING DEPTHS

	3 TRACK	4 TRACK	5 TRACK
Minimum IB	2"	2 3/4"	3 3/8"
Flush IB	2 1/2"	3 1/4"	3 7/8"

Wall or Face Mount: 1 3/4" flat mounting surface required.  
(Using L Bracket)

## INSIDE MOUNT DEDUCTIONS

IB Deduction (Width): 1/4"

IB Deduction (Height): 1/2"

## DISTANCE FROM THE WALL TO THE BACK OF THE TRACK (CLEARANCE)

	3-CHANNEL TRACK	4-CHANNEL TRACK	5-CHANNEL TRACK
Standard Bracket (2 7/8")	1 3/8"	1 1/4"	3/4"
Large Bracket (4 1/4")	2 1/2"	2 3/8"	1 7/8"

Adding an extension bracket will provide an extra 2 7/8" of clearance from the wall.

Add the track depth to the clearance to calculate the total projection into the room.

## SLIDING PANEL BRACKET

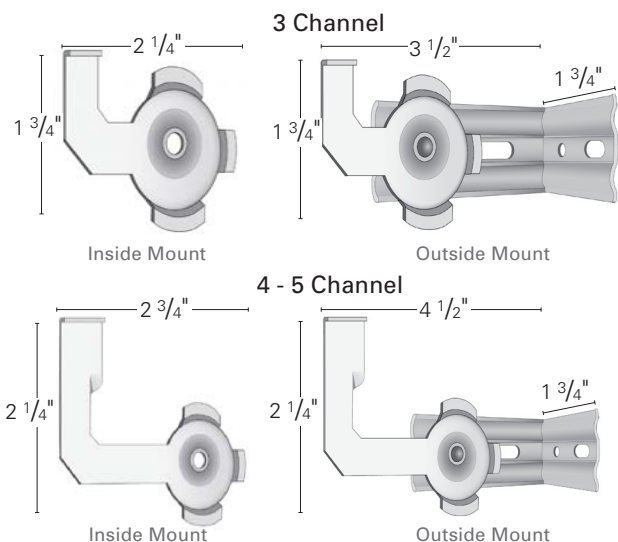

# SLIDING PANEL CONFIGURATIONS

## GENERAL OPERATION

Open

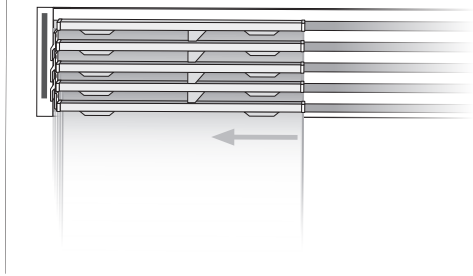

Closed

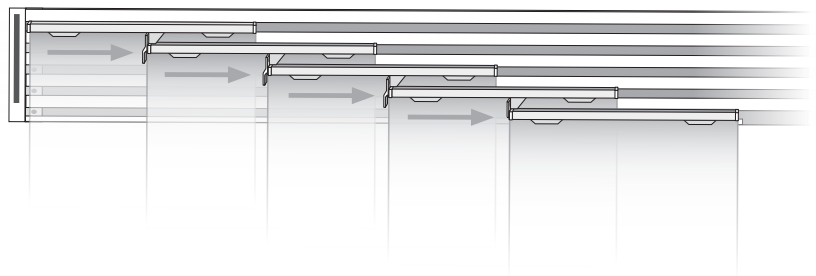

## ONE WAY CONFIGURATIONS

3 Channel Track / 3 Panels / One Way Left

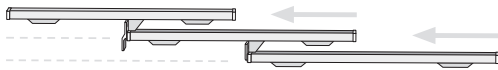

3 Channel Track / 3 Panels / One Way Right

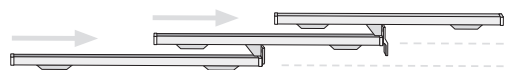

4 Channel Track / 4 Panels / One Way Left

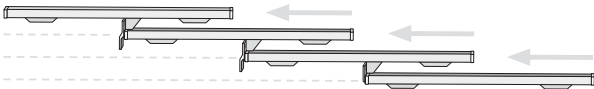

4 Channel Track / 4 Panels / One Way Right

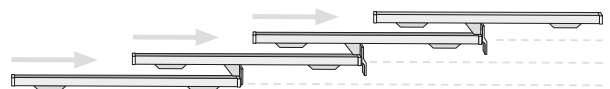

5 Channel Track / 5 Panels / One Way Left

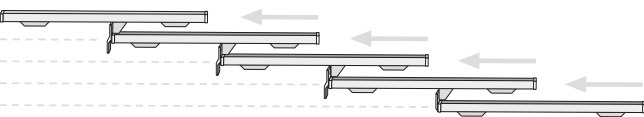

5 Channel Track / 5 Panels / One Way Right

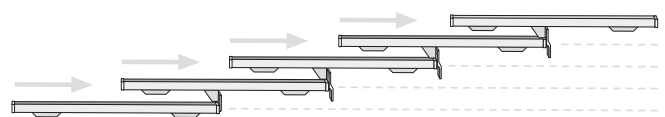

## CENTER SPLIT CONFIGURATIONS

2 Channel Track / 4 Panels / Center Split  
(stationary back left and front right)



4 Channel Track / 6 Panels / Center Split

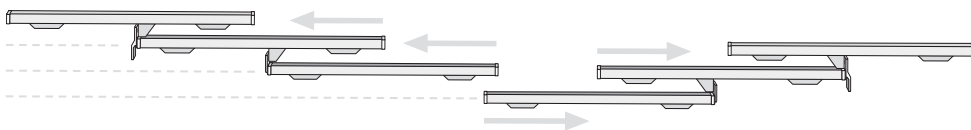

5 Channel Track / 8 Panels / Center Split

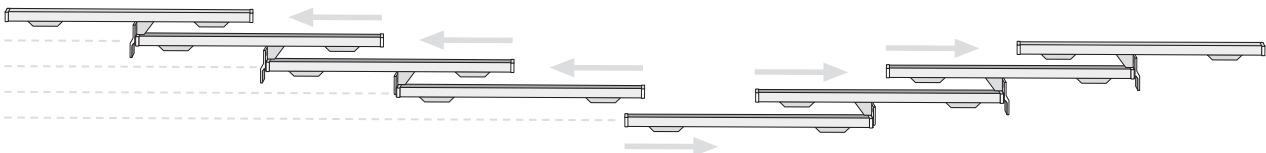

# SHADE PRICING GROUPS A - D

Includes Standard Roman and Waterfall Shades.

## WIDTH

PRICE GROUP A Devon Penang Oak Sunshade Brown		LENGTH	24"	30"	36"	42"	48"	60"	72"	84"	96"
			36"	\$156	\$161	\$195	\$217	\$241	\$295	\$332	\$385
48"	\$178	\$204	\$229	\$259	\$285	\$354	\$395	\$462	\$509		
54"	\$190	\$229	\$247	\$276	\$311	\$384	\$436	\$498	\$554		
60"	\$200	\$238	\$267	\$295	\$324	\$408	\$477	\$535	\$600		
66"	\$211	\$247	\$285	\$315	\$349	\$466	\$512	\$589	\$662		
72"	\$221	\$261	\$303	\$336	\$369	\$486	\$540	\$645	\$723		
78"	\$235	\$278	\$321	\$362	\$402	\$516	\$584	\$683	\$769		
84"	\$248	\$295	\$341	\$385	\$436	\$546	\$615	\$723	\$823		
96"	\$272	\$325	\$379	\$428	\$477	\$622	\$711	\$829	\$943		
108"	\$306	\$365	\$425	\$481	\$536	\$698	\$799	\$931	\$1,060		

PRICE GROUP B Alder Oak Bamboo Forest Barcelona Café Bora Bora Driftwood Natural Java Cocoa Tamarind Sunset		LENGTH	24"	30"	36"	42"	48"	60"	72"	84"	96"
			36"	\$189	\$208	\$243	\$264	\$285	\$332	\$377	\$442
48"	\$228	\$261	\$295	\$324	\$352	\$401	\$451	\$535	\$624		
54"	\$237	\$276	\$313	\$346	\$377	\$433	\$489	\$580	\$670		
60"	\$248	\$290	\$332	\$367	\$401	\$466	\$527	\$624	\$715		
66"	\$261	\$307	\$351	\$389	\$427	\$497	\$566	\$666	\$760		
72"	\$274	\$323	\$371	\$411	\$451	\$527	\$605	\$708	\$803		
78"	\$286	\$338	\$390	\$434	\$477	\$559	\$643	\$748	\$849		
84"	\$298	\$354	\$408	\$455	\$502	\$592	\$680	\$788	\$895		
96"	\$325	\$403	\$446	\$499	\$551	\$683	\$790	\$909	\$1,025		
108"	\$365	\$434	\$501	\$561	\$619	\$767	\$887	\$1,022	\$1,151		

PRICE GROUP C Aspen Mandalay Umber Sakura Oregon Savanna Husk Sunshade White		LENGTH	24"	30"	36"	42"	48"	60"	72"	84"	96"
			36"	\$219	\$247	\$278	\$297	\$332	\$411	\$480	\$585
48"	\$242	\$281	\$320	\$345	\$369	\$476	\$555	\$672	\$795		
54"	\$258	\$300	\$343	\$372	\$399	\$503	\$609	\$732	\$839		
60"	\$274	\$320	\$364	\$397	\$436	\$548	\$643	\$769	\$903		
66"	\$291	\$338	\$385	\$419	\$467	\$592	\$697	\$831	\$966		
72"	\$306	\$356	\$406	\$442	\$493	\$644	\$757	\$901	\$1,044		
78"	\$323	\$376	\$429	\$476	\$536	\$682	\$800	\$953	\$1,107		
84"	\$337	\$394	\$451	\$510	\$567	\$718	\$844	\$1,004	\$1,168		
96"	\$367	\$432	\$494	\$558	\$632	\$816	\$970	\$1,139	\$1,312		
108"	\$414	\$486	\$555	\$628	\$711	\$918	\$1,091	\$1,281	\$1,476		

PRICE GROUP D Capri Natural Telluride		LENGTH	24"	30"	36"	42"	48"	60"	72"	84"	96"
			36"	\$254	\$267	\$300	\$321	\$341	\$433	\$506	\$614
48"	\$264	\$299	\$347	\$375	\$402	\$510	\$598	\$721	\$843		
54"	\$281	\$332	\$382	\$407	\$432	\$546	\$644	\$773	\$904		
60"	\$297	\$358	\$405	\$438	\$460	\$583	\$689	\$826	\$964		
66"	\$313	\$372	\$429	\$459	\$490	\$666	\$766	\$903	\$1,051		
72"	\$332	\$385	\$440	\$481	\$522	\$700	\$823	\$979	\$1,136		
78"	\$345	\$405	\$463	\$550	\$567	\$739	\$870	\$1,035	\$1,201		
84"	\$364	\$425	\$486	\$581	\$613	\$779	\$917	\$1,087	\$1,267		
96"	\$399	\$468	\$536	\$588	\$674	\$901	\$1,060	\$1,259	\$1,457		
108"	\$449	\$527	\$604	\$662	\$757	\$1,013	\$1,193	\$1,416	\$1,639		

## SHADE PRICING GROUPS E - F

Includes Standard Roman and Waterfall Shades.

### WIDTH

PRICE GROUP E		WIDTH								
		24"	30"	36"	42"	48"	60"	72"	84"	96"
Artisan Weave Catalina Natural Jute Orleans Macaroon Prairie Golden Prairie White Remi Breeze Saybrook Stone	36"	\$279	\$293	\$331	\$353	\$375	\$476	\$557	\$675	\$797
	48"	\$290	\$329	\$382	\$412	\$442	\$561	\$658	\$793	\$927
	54"	\$309	\$365	\$421	\$448	\$475	\$601	\$708	\$850	\$994
	60"	\$326	\$393	\$445	\$482	\$506	\$641	\$758	\$909	\$1,060
	66"	\$345	\$409	\$472	\$505	\$539	\$733	\$843	\$993	\$1,156
	72"	\$365	\$424	\$484	\$529	\$574	\$770	\$906	\$1,077	\$1,249
	78"	\$379	\$445	\$509	\$605	\$624	\$813	\$957	\$1,139	\$1,321
	84"	\$401	\$468	\$535	\$639	\$674	\$857	\$1,009	\$1,196	\$1,394
	96"	\$439	\$515	\$589	\$647	\$741	\$992	\$1,166	\$1,385	\$1,602
	108"	\$494	\$579	\$664	\$728	\$833	\$1,115	\$1,312	\$1,558	\$1,803

PRICE GROUP F		WIDTH								
		24"	30"	36"	42"	48"	60"	72"	84"	96"
Aires White Mykonos Dunes Navarre White Sand Prairie Snow Seaside White	36"	\$328	\$371	\$418	\$445	\$498	\$617	\$720	\$878	\$1,013
	48"	\$363	\$421	\$480	\$517	\$554	\$714	\$833	\$1,009	\$1,192
	54"	\$386	\$451	\$515	\$558	\$599	\$755	\$913	\$1,098	\$1,258
	60"	\$412	\$480	\$546	\$595	\$654	\$821	\$964	\$1,153	\$1,354
	66"	\$437	\$507	\$578	\$628	\$700	\$888	\$1,046	\$1,247	\$1,450
	72"	\$458	\$535	\$609	\$663	\$739	\$966	\$1,136	\$1,352	\$1,567
	78"	\$484	\$564	\$644	\$714	\$804	\$1,022	\$1,200	\$1,430	\$1,660
	84"	\$505	\$591	\$677	\$765	\$851	\$1,077	\$1,266	\$1,506	\$1,752
	96"	\$550	\$648	\$741	\$837	\$948	\$1,223	\$1,455	\$1,709	\$1,969
	108"	\$620	\$730	\$833	\$942	\$1,067	\$1,377	\$1,637	\$1,922	\$2,214

# SHADE SURCHARGE OPTION PRICING

Add any applicable surcharges to the retail price of the basic shade.

## WIDTH

		WIDTH									
		24"	30"	36"	42"	48"	60"	72"	84"	96"	
<b>PRIVACY LINER</b> Privacy Beige Privacy Chocolate Privacy White  Privacy Liners are the same color on both sides	<b>LENGTH</b>	36"	\$31	\$40	\$47	\$55	\$63	\$78	\$94	\$110	\$126
		48"	\$41	\$51	\$61	\$71	\$81	\$102	\$121	\$141	\$162
		54"	\$45	\$56	\$67	\$78	\$90	\$113	\$135	\$157	\$180
		60"	\$50	\$62	\$74	\$87	\$99	\$124	\$149	\$173	\$198
		66"	\$55	\$67	\$81	\$94	\$108	\$135	\$162	\$188	\$216
		72"	\$58	\$73	\$88	\$103	\$116	\$146	\$175	\$204	\$234
		78"	\$63	\$78	\$94	\$110	\$126	\$157	\$188	\$221	\$251
		84"	\$67	\$84	\$102	\$118	\$135	\$168	\$202	\$235	\$270
		96"	\$77	\$95	\$115	\$134	\$152	\$191	\$229	\$268	\$306
		108"	\$85	\$107	\$128	\$150	\$171	\$213	\$256	\$299	\$342

		WIDTH									
		24"	30"	36"	42"	48"	60"	72"	84"	96"	
<b>BLACK-OUT LINER</b> Black-Out Beige Black-Out Chocolate Black-Out White  Black-Out Liners are off-white to the street	<b>LENGTH</b>	36"	\$33	\$41	\$50	\$58	\$66	\$83	\$99	\$115	\$133
		48"	\$42	\$53	\$63	\$74	\$85	\$107	\$128	\$149	\$170
		54"	\$47	\$59	\$71	\$83	\$94	\$118	\$141	\$165	\$190
		60"	\$52	\$64	\$78	\$90	\$104	\$130	\$156	\$182	\$208
		66"	\$57	\$71	\$85	\$99	\$114	\$141	\$170	\$198	\$227
		72"	\$62	\$77	\$92	\$108	\$123	\$154	\$185	\$216	\$245
		78"	\$66	\$83	\$99	\$115	\$133	\$165	\$198	\$232	\$265
		84"	\$71	\$89	\$107	\$124	\$141	\$177	\$213	\$248	\$284
		96"	\$81	\$100	\$120	\$140	\$161	\$201	\$242	\$281	\$321
		108"	\$89	\$113	\$135	\$157	\$180	\$224	\$269	\$315	\$359

		WIDTH									
		24"	30"	36"	42"	48"	60"	72"	84"	96"	
<b>NARROW EDGE BINDING</b> Beige Black Chocolate Copper Cream Desert Sand Light Beige Natural Sienna White	<b>LENGTH</b>	36"	\$35	\$36	\$38	\$40	\$42	\$46	\$50	\$53	\$57
		48"	\$42	\$43	\$46	\$47	\$50	\$53	\$57	\$61	\$64
		54"	\$46	\$47	\$50	\$51	\$53	\$57	\$61	\$64	\$68
		60"	\$50	\$51	\$53	\$55	\$57	\$61	\$64	\$68	\$72
		66"	\$53	\$55	\$57	\$58	\$61	\$64	\$68	\$72	\$76
		72"	\$57	\$58	\$61	\$62	\$64	\$68	\$72	\$76	\$79
		78"	\$61	\$62	\$64	\$66	\$68	\$72	\$76	\$79	\$83
		84"	\$64	\$66	\$68	\$71	\$72	\$76	\$79	\$83	\$87
		96"	\$72	\$74	\$76	\$78	\$79	\$83	\$87	\$90	\$94
		108"	\$79	\$82	\$83	\$85	\$87	\$90	\$94	\$98	\$103

		WIDTH									
		24"	30"	36"	42"	48"	60"	72"	84"	96"	
<b>WIDE EDGE BINDING</b> Beige Black Chocolate Copper Cream Desert Sand Light Beige Natural Sienna White	<b>LENGTH</b>	36"	\$45	\$47	\$50	\$52	\$55	\$59	\$64	\$69	\$74
		48"	\$55	\$57	\$59	\$62	\$64	\$69	\$74	\$79	\$84
		54"	\$59	\$62	\$64	\$67	\$69	\$74	\$79	\$84	\$89
		60"	\$64	\$67	\$69	\$72	\$74	\$79	\$84	\$89	\$94
		66"	\$69	\$72	\$74	\$77	\$79	\$84	\$89	\$94	\$99
		72"	\$74	\$77	\$79	\$82	\$84	\$89	\$94	\$99	\$104
		78"	\$79	\$82	\$84	\$87	\$89	\$94	\$99	\$104	\$109
		84"	\$84	\$87	\$89	\$92	\$94	\$99	\$104	\$109	\$114
		96"	\$94	\$97	\$99	\$102	\$104	\$109	\$114	\$119	\$124
		108"	\$104	\$107	\$109	\$111	\$114	\$119	\$124	\$129	\$134

# SHADE SURCHARGE OPTION PRICING

Add any applicable surcharges to the retail price of the basic shade.

## STYLE OPTIONS

CLUTCH (priced by width)

24"	30"	36"	42"	48"	60"	72"	84"	96"
\$105	\$123	\$140	\$152	\$158	\$164	\$175	\$187	\$199

CORDLESS

Up to 48" width: **\$105**

Up to 72" width: **\$137**

Above 72" width: **\$168**

MULTIPLE SHADES ON ONE HEAD RAIL

Add surcharge to price of two/three individual shades:

2-on-1: **\$47** surcharge

3-on-1: **\$59** surcharge

TWIN SHADE (movable liner): **\$140** surcharge

Add surcharge to cost of shade with liner.

TDBU: **\$53**

FABRIC VALANCE RETURNS: **\$36**

Made of edge binding material.

OPTIONAL LINED VALANCE: **\$18**

STAINLESS STEEL CHAIN: **\$34**

CUT OUTS: **\$36** each cut out

## WAND CONTROL SHADES

WAND CONTROL MOTOR: **\$231** (includes Wand)

### WAND CONTROL BATTERY CHARGER

Chargers are not included with motorized shades; please identify desired quantity when placing order.

USB WAND CHARGER: **\$59**



White, beige, gray, bronze, or black wands

## REMOTE CONTROL SHADES

REMOTE CONTROL MOTOR (LI, DC, AND AC STYLES): **\$408**

QUIET LIFT MOTOR: **\$562**

### REMOTES

SINGLE-CHANNEL REMOTE: **\$64**

MULTI-CHANNEL REMOTE: **\$82**



Single-Channel Remote



Multi-Channel Remote

### WALL SWITCHES

SINGLE-CHANNEL SWITCH: **\$114**

MULTI-CHANNEL SWITCH: **\$146**



Single-Channel Switch



Multi-Channel Switch

### CONNECTOR

HUB: **\$330**



Connector Motor Hub

### REMOTE CONTROL BATTERY CHARGERS

Chargers are not included with motorized shades; please identify desired quantity when placing order.

USB REMOTE CHARGER (w/6 ft cable): **\$59**

USB REMOTE CHARGER (w/16½ ft cable): **\$74**

# SLIDING PANEL PRICING GROUPS A - D

All tracks and valance boards over 90" wide will be spliced to avoid oversize freight charges

## WIDTH

PRICE GROUP A Devon Penang Oak Sunshade Brown	LENGTH	60"	72"	84"	96"	108"	120"	132"	144"
		60"	\$598	\$673	\$754	\$853	\$929	\$1,010	\$1,090
	72"	\$647	\$730	\$819	\$929	\$1,012	\$1,101	\$1,192	\$1,270
	84"	\$696	\$787	\$883	\$1,005	\$1,096	\$1,192	\$1,294	\$1,380
	96"	\$745	\$844	\$948	\$1,081	\$1,180	\$1,284	\$1,396	\$1,490
Valance		\$43	\$51	\$60	\$68	\$77	\$85	\$94	\$102

PRICE GROUP B Alder Bamboo Forest Barcelona Café Bora Bora Driftwood Natural Java Cocoa Tamarind Sunset	LENGTH	60"	72"	84"	96"	108"	120"	132"	144"
		60"	\$611	\$688	\$772	\$874	\$952	\$1,035	\$1,118
	72"	\$663	\$748	\$840	\$954	\$1,040	\$1,132	\$1,226	\$1,307
	84"	\$715	\$809	\$908	\$1,035	\$1,128	\$1,228	\$1,333	\$1,423
	96"	\$767	\$869	\$977	\$1,115	\$1,217	\$1,325	\$1,441	\$1,538
Valance		\$45	\$54	\$63	\$72	\$80	\$89	\$98	\$107

PRICE GROUP C Aspen Mandalay Umber Sakura Oregano Savanna Husk Sunshade White	LENGTH	60"	72"	84"	96"	108"	120"	132"	144"
		60"	\$623	\$702	\$788	\$893	\$972	\$1,058	\$1,143
	72"	\$677	\$765	\$859	\$977	\$1,065	\$1,159	\$1,255	\$1,339
	84"	\$731	\$828	\$931	\$1,060	\$1,157	\$1,260	\$1,368	\$1,460
	96"	\$786	\$891	\$1,002	\$1,144	\$1,250	\$1,361	\$1,481	\$1,581
Valance		\$47	\$56	\$65	\$74	\$84	\$93	\$102	\$112

PRICE GROUP D Capri Natural Sierra Sand Telluride	LENGTH	60"	72"	84"	96"	108"	120"	132"	144"
		60"	\$662	\$749	\$842	\$955	\$1,042	\$1,135	\$1,226
	72"	\$725	\$821	\$924	\$1,052	\$1,148	\$1,251	\$1,356	\$1,448
	84"	\$787	\$894	\$1,006	\$1,148	\$1,255	\$1,367	\$1,485	\$1,587
	96"	\$849	\$966	\$1,089	\$1,244	\$1,361	\$1,484	\$1,615	\$1,727
Valance		\$53	\$63	\$74	\$84	\$95	\$105	\$116	\$126

## SLIDING PANEL PRICING GROUPS E - F

All tracks and valance boards over 90" wide will be spliced to avoid oversize freight charges

### WIDTH

PRICE GROUP E Artisan Weave Catalina Natural Jute Orleans Macaroon Prairie Golden Prairie White Remi Breeze Saybrook Stone	LENGTH	60"	72"	84"	96"	108"	120"	132"	144"
		60"	\$747	\$845	\$950	\$1,078	\$1,175	\$1,280	\$1,383
	72"	\$817	\$927	\$1,042	\$1,186	\$1,295	\$1,411	\$1,529	\$1,633
	84"	\$888	\$1,008	\$1,135	\$1,295	\$1,415	\$1,542	\$1,675	\$1,791
	96"	\$958	\$1,090	\$1,228	\$1,404	\$1,535	\$1,674	\$1,821	\$1,948
Valance		\$59	\$71	\$83	\$95	\$107	\$119	\$131	\$143

PRICE GROUP F Aires White Mykonos Dunes Navarre White Sand Prairie Snow Seaside White	LENGTH	60"	72"	84"	96"	108"	120"	132"	144"
		60"	\$1,009	\$1,141	\$1,282	\$1,455	\$1,587	\$1,728	\$1,868
	72"	\$1,104	\$1,251	\$1,407	\$1,601	\$1,749	\$1,905	\$2,065	\$2,205
	84"	\$1,198	\$1,361	\$1,533	\$1,748	\$1,911	\$2,082	\$2,262	\$2,417
	96"	\$1,293	\$1,471	\$1,658	\$1,895	\$2,073	\$2,259	\$2,459	\$2,629
Valance		\$80	\$96	\$112	\$128	\$144	\$160	\$176	\$193

## SLIDING PANEL OPTION PRICING

### WIDTH

PRIVACY LINER Privacy Beige Privacy Chocolate Privacy White	LENGTH	60"	72"	84"	96"	108"	120"	132"	144"
		60"	\$183	\$207	\$232	\$262	\$286	\$311	\$335
	72"	\$199	\$225	\$252	\$286	\$312	\$340	\$368	\$392
Privacy Liners are the same color on both sides	84"	\$214	\$243	\$273	\$310	\$339	\$368	\$400	\$427
	96"	\$230	\$261	\$293	\$334	\$365	\$397	\$432	\$461
Valance		\$13	\$16	\$19	\$21	\$24	\$27	\$30	\$32

BLACK-OUT LINER Black-Out Beige Black-Out Chocolate Black-Out White	LENGTH	60"	72"	84"	96"	108"	120"	132"	144"
		60"	\$244	\$275	\$309	\$350	\$381	\$414	\$447
	72"	\$265	\$299	\$336	\$382	\$416	\$453	\$490	\$523
Black-Out Liners are off-white to the street	84"	\$286	\$323	\$363	\$414	\$451	\$491	\$533	\$569
	96"	\$307	\$347	\$391	\$446	\$487	\$530	\$576	\$615
Valance		\$18	\$21	\$25	\$29	\$32	\$36	\$39	\$43

WIDE EDGE BINDING: **\$205**

NET FREIGHT SURCHARGE: **\$40**

# NOMISTAR WOVEN WOOD WARRANTY

## LIMITED LIFETIME WARRANTY

This product is warranted against defects in materials and workmanship, provided that:

1. The product was installed according to the product instructions.
2. NomiStar recommendations were followed regarding limitations and specifications of the product.

NomiStar reserves the right to determine if your shade warrants a repair or partial replacement of any parts. If necessary, NomiStar will replace your shade with a new shade of equal or superior value. This shall be your sole remedy under this warranty.

This Limited Lifetime Warranty excludes all motors, controls and accessories that are warranted for only a period of five years from the date of purchase. Failure to follow the proper installation, charging and use instructions will invalidate the warranty for motors, remotes, wands and hubs.

This Limited Lifetime Warranty applies only to the original retail purchaser with proof of purchase.

This Limited Lifetime Warranty does not cover the removal or installation of original or replacement shades. This Limited Lifetime Warranty does not cover damage or defects caused by, or resulting from improper maintenance, neglect or improper use, wear and tear, abuse, neglect, accidents, alteration, commercial use, installation, removal or reinstallation or exposure to excessive moisture.

## YOUR RIGHTS UNDER STATE LAW

These warranties give you specific legal rights. You may also have other rights which may vary from State to State. In no event shall NomiStar be liable for incidental or consequential damages or for any other direct or indirect damage, loss, cost, expense or fee. Some states do not allow the exclusion or limitation of incidental or consequential damages, so the above limitation or exclusion may not apply to you. These warranties are exclusive and in lieu of all other obligations, liabilities, disclaimers, or warranties.

# WALDEN PREMIER

## ⚠️ WARNING

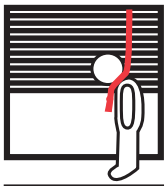

### Window Blind Cord Can STRANGLE Your Child.

To prevent strangulation, purchase cordless products or products with inaccessible cords.

ANSIWMA 5.1.3

## ⚠️ ADVERTENCIA



### La cuerda ciega de la ventana puede ESTRANGULAR su niño.

Para evitar el estrangulamiento, compre alternativas inalámbricas o productos con cables inaccesibles.

ANSIWMA 5.1.3